



HERAEUS
FALCONER

MEASURING RECEIVER
SERIES 1000
PRECISION MEASURING RECEIVER
SERIES 1000

TECHNICAL DATA • NOVEMBER 1985

Precision Measuring Receiver



Precise Signal Analysis . . .

- **RF Power:** digital power meter accuracy
- **AM and FM:** $\pm 1\%$ absolute accuracy
 ϕM : $\pm 3\%$ absolute accuracy
- **Tuned RF Level:** 0 dBm to -127 dBm with better than ± 0.03 dB accuracy per 10 dB step
- **Carrier Noise:** AM and phase noise measurements to -140 dBc/Hz
- **RF Frequency:** 1 Hz resolution
- **Audio Characterization:**
AC Volts: $\pm 4\%$ accuracy
Frequency: 6 digits of resolution
Distortion: ± 1 dB Accuracy

The **HP 8902A Measuring Receiver** combines six precision measurement functions into one fully automatic, HP-IB programmable instrument. It accurately measures **RF power, tuned RF level, carrier noise/adjacent channel power, modulation and RF frequency**, and characterizes **audio** signals. For precise signal analysis, the HP 8902A Measuring Receiver provides the performance you need, the features you want, and the reliability and serviceability you expect.

RF Power delivers the accuracy and resolution of a high performance power meter. The HP 8902A with the HP 11722A Sensor Module measures power from +30 dBm to -20 dBm at frequencies from 100 kHz to 2.6 GHz. The HP 8902A also accepts all HP 8480 series power sensors for extended measurement capability.

Tuned RF Level's minimum sensitivity of -127 dBm with exceptional accuracy is a major contribution of the HP 8902A. You can make relative level measurements with accuracy you would only expect from a transfer standard: ± 0.02 dB ± 1 digit (worst case) for up to 10 dB step, increasing to ± 0.30 dB ± 1 digit at 110 dB step.

Carrier noise, phase noise and adjacent channel power measurements are simple, fast and accurate with the HP 8902A's high selectivity options (030-037). You select the noise filter bandwidth, measure the source under test's carrier power, tune the analyzer to the frequency offset desired (5 kHz to 1300 MHz) and measure the noise in seconds. The analyzer's measurement accuracy is better than ± 0.5 dB to -129 dBc/Hz, typically better than ± 1 dB to -140 dBc/Hz. The noise floor is -150 dBc/Hz.

AM and FM measurements offer $\pm 1\%$ accuracy ($\pm 3\%$ accuracy for ϕM) and fast single-key operation. The HP 8902A has extremely low internal noise, and very low AM/ ϕM and ϕM /AM conversion, for accurately measuring residual and incidental AM, FM and ϕM on a wide range of simple and complex modulated signals.

RF frequency of complex modulated signals can be difficult to measure, but not with the HP 8902A. It tunes to the largest input signal or to any user specified frequency. The HP 8902A counts signals with 1 Hz resolution.

Audio distortion, frequency and level measurements provide comprehensive characterization of the modulation signal.

HP 8902A Measuring Receiver And HP 11722A Sensor

The large 10-digit LED displays all measured results and error messages.

In TRACK, swept signal setting

Indicators display current HP-IB status.

Independently selectable HIGH-PASS and LOW-PASS FILTERS match the post-detection bandwidth to the application.

Four standard DE-EMPHASIS networks are available for FM measurements. Using the PRE-DISPLAY key, the de-emphasis networks are positioned before the displayed measurement circuit, to display "de-emphasized" FM deviation.

ZERO the HP 11722A Sensor Module without removing it from the device under test.

RF POWER calibrator supplies an accurate 1 mW reference for RF power calibration.

AM/FM calibrator provides extremely accurate signals for modulation calibration. AM depth and FM deviation are calibrated to 0.1% accuracy.

Modulation DETECTOR keys select POSITIVE PEAK, NEGATIVE PEAK, \pm PEAK/2, AVERAGE, or RMS DETECTORS. PEAK HOLD is used with either peak detector for measuring transients.

Select the display

Rear Panel

RECORDER OUTPUT provides a dc voltage proportional to the measured result.

REMOTE CONTROL provides output for user configured power sensor/receiver input switch.

TTL level indicates FREQUENCY OFF-SET Mode.

Module

MODE, the Measuring Receiver continuously tracks a drifting or drifting or even at low signal levels. RANGE HOLD freezes the instrument's readings at their current value.

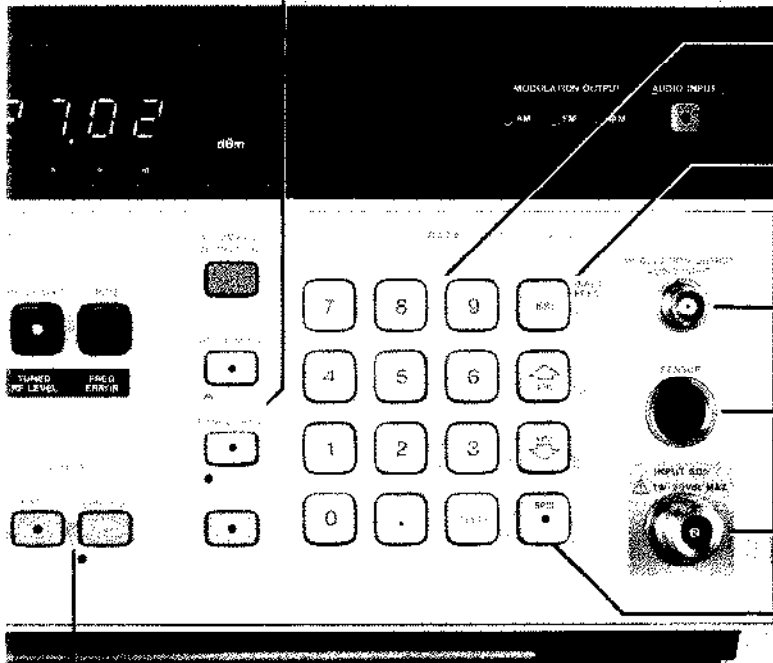

STORE and RECALL instrument settings in eight non-volatile memory locations.

Enter RF Power calibration factors into non-volatile memory for automatic compensation of power sensor efficiency and mismatch loss.

This connector has two functions. It serves as a recovered MODULATION OUTPUT for external measurements, or external AUDIO INPUT for ac level, frequency or distortion measurements.

The Measuring Receiver automatically recognizes which power sensor is used and sets the appropriate power ranges.

RF INPUT accepts signals from +30 dBm to -127 dBm, and 150 kHz to 1300 MHz.

SPECIAL FUNCTION key for complete control of Measuring Receiver functions. This key also executes many built-in troubleshooting routines.

Stable formats by results in units desired.

Pull-out INFORMATION CARDS for quick reference to instrument operation, special functions, and error messages.

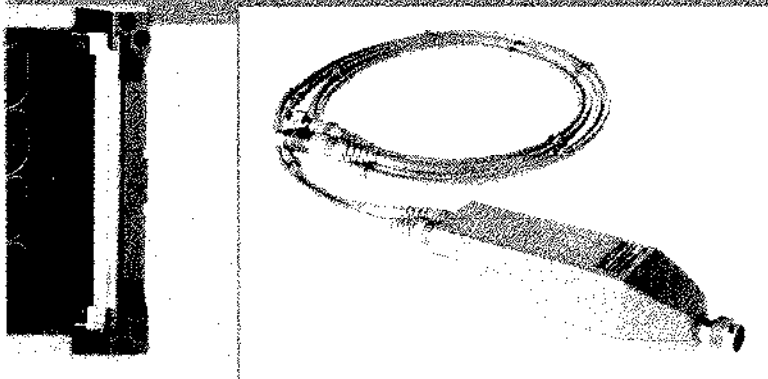

HP 11722A Sensor

With the HP 11722A Sensor Module, all measurements including RF Power are made at a single connector.



HP-IB: Not just IEEE-488, but the hardware, documentation and support that delivers the shortest path to a measurement system.

... For Your Applications

Metrology and Calibration

The HP 8902A Measuring Receiver makes signal generator and attenuator calibration easier than ever before.

The HP 8902A quickly and accurately measures your signal generator's RF frequency, RF level flatness, output level accuracy to -127 dBm, AM, FM and phase modulation, phase noise to less than -140 dBc/Hz, and it characterizes the demodulated audio signals.

For attenuator calibration and other relative measurements, the HP 8902A gives you the accuracy and dynamic range you need. Tuned RF Level makes relative measurements with 127 dB dynamic range and .001 dB resolution. The combined dynamic range of Tuned RF Level and RF Power is 157 dB.

RF Signal Characterization

The HP 8902A Measuring Receiver is an excellent lab and production tool for accurately characterizing RF signals from 150 kHz to 1300 MHz.

Level measurements down to -127 dBm with superb accuracy make the HP 8902A ideal for testing devices such as antennas, multiplexers, Log/Linear amplifiers, filters and mixers. Unlike diode peak detectors, the HP 8902A's power meter accurately measures signals with harmonics and spurious.

The HP 8902A makes accurate AM to ϕ M and FM to AM conversion measurements of phase and amplitude sensitive devices such as bandpass filters and multiple channel receivers. Excellent isolation between AM and FM makes it simple to separate the AM and ϕ M of AM stereo, incidental AM of FM transmitters and the AM, FM and ϕ M components of complex signals.

Automatic Test Systems

The HP 8902A is an important component of automatic RF test systems. All functions—power, level, frequency count, carrier noise, modulation, and audio analysis—are fully automatic and easily programmed. With these measurements combined into one instrument, interfacing requirements, hardware costs, and software development time are reduced.

The HP 8902A's excellent measurement accuracy and dynamic range also make it a valuable tool for calibrating automatic test systems.

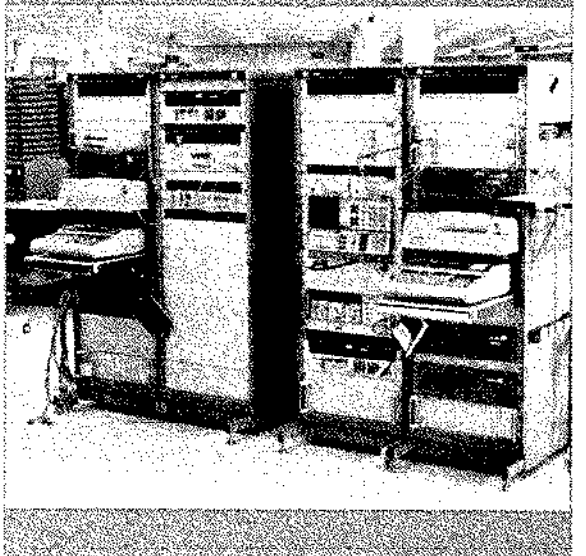
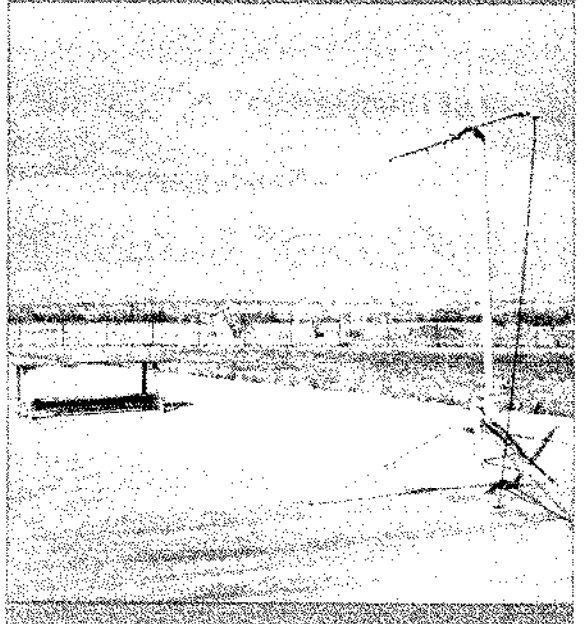
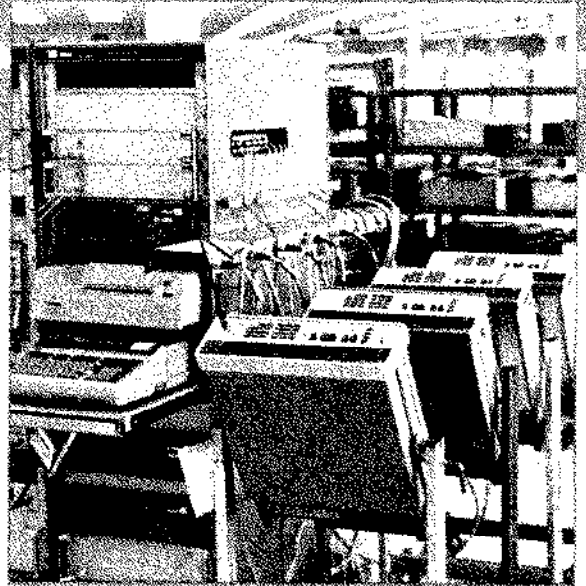

Performance You Need

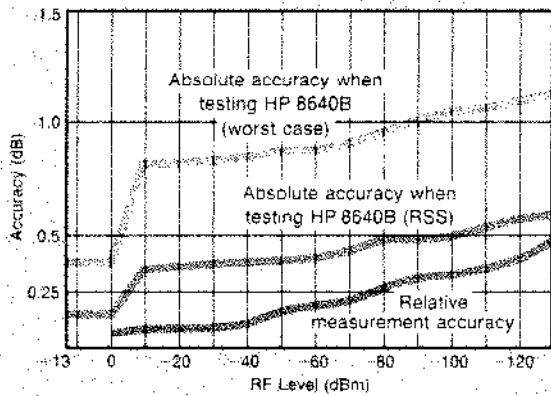

Tuned RF Level: Transfer Standard Accuracy at the Push of a Button

The HP 8902A Measuring Receiver delivers unprecedented RF level performance, measuring signal levels down to -127 dBm in only a few seconds with typically better than 0.5 dB_{RSS} absolute accuracy. Relative measurement accuracy is even better: ± 0.02 dB ± 1 digit (worst case) up to 10 dB step, increasing to ± 0.30 dB ± 1 digit at 110 dB step.

This level of performance is made possible by a precise IF substitution technique. The HP 8902A

derives its superb accuracy from the highly linear IF amplifiers and HP's IF Synchronous Detector, while calibrating out many of the uncertainties of the RF attenuators and RF amplifier.

Achieving the utmost accuracy requires a simple calibration. The RECAL indicator on the front panel prompts you to push the CALIBRATE key whenever an absolute level or RF range calibration may be performed. Complete calibration to -127 dBm requires at most three steps, and you only perform this

process once at any frequency. The three resulting calibration factors are stored in non-volatile memory. Using an external HP-IB controller, you can calibrate the instrument at several frequencies, store the cal factors in the controller, and recall them later as needed.

Hewlett-Packard's HP 8902A Measuring Receiver gives you the speed, accuracy and dynamic range you need when you make level measurements. Using Tuned RF Level and RF Power together, you can measure levels from $+30$ dBm to -127 dBm (157 dB dynamic range) with state-of-the-art accuracy.

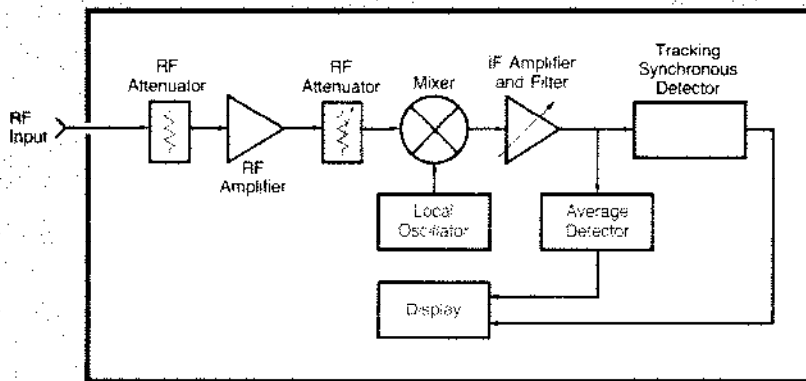

Carrier Noise: Simple and Accurate Phase Noise Measurements

The HP 8902A Measuring Receiver offers optional selective power measurement capability (Options 030-037). Used with a low-noise external LO, the HP 8902A performs fast, accurate single-sideband (SSB) carrier noise measurements to 1.3 GHz. To make a carrier-noise (AM noise and phase noise) measurement, you select the noise filter (2.5 kHz noise bandwidth), measure the source under test's carrier power, tune the analyzer to the frequency offset desired (5 kHz to 1300 MHz) and measure the noise. The data is displayed in real time, either as dBc in a 1 Hz bandwidth or as total power in the 2.5 kHz filter bandwidth.

Phase noise usually dominates the carrier-noise measurement at most offsets of interest, so direct-spectrum noise measurements provide a convenient and simple way to measure phase noise of many sources. This measurement technique is relatively insensitive to many common pitfalls encountered in making phase noise measurements. There is no need to phase-lock signals. Testing can be fully automated using an external controller. Most important, selective signal and noise measurements are fast (five readings per second). The analyzer's measurement accuracy is better than ± 0.5 dB to -129 dBc/Hz, typically better than ± 1 dB to -140 dBc/Hz. The noise floor is -150 dBc/Hz.

Many applications require spectral purity to be expressed as residual AM, FM or phase modulation. With the HP 8902A's convenient modulation capabilities you make these measurements with one keystroke, in a variety of common bandwidths.

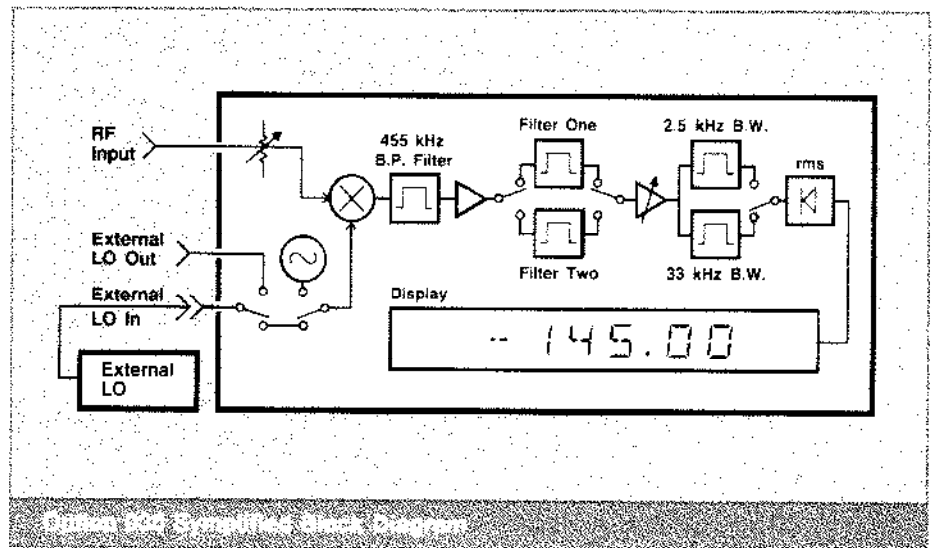
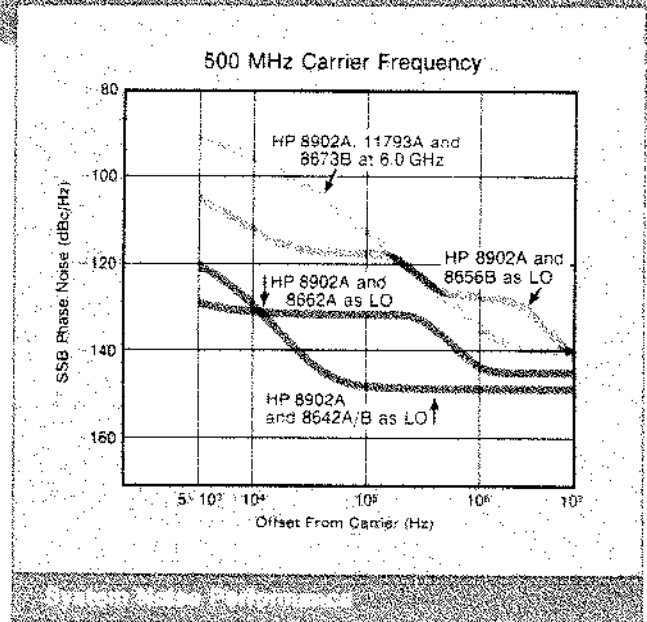

To extend the measurement range to 26.5 GHz, add the HP 11793A Microwave Converter and a low noise microwave source, such as the HP 8673B Synthesized Signal Generator. With this system you can test high-performance sources from 10 MHz to 26.5 GHz.

Performance You Need

Adjacent Channel Power Measurements: Meet CEPT's Stringent Standards

The HP 8902A Measuring Receiver's easy-to-use selective power measurement option also saves you time and money, speeding adjacent-channel power testing on your RF communications transmitters. These selective measurements meet the stringent CEPT standards for adjacent-channel power with superb accuracy: ± 0.5 dB; dynamic range > 115 dB; and selectivity > 90 dB.

Making an adjacent channel power measurement is simple. You first select the appropriate filter (12.5, 25 or 30 kHz channel spacing) and measure the transmitter carrier power. Then, tune the analyzer to any offset desired, and measure the channel power. The analyzer displays the results in dBc (dB relative to the carrier power).

To meet the CEPT noise-floor requirements at frequencies greater than 300 MHz, the HP 8902A requires an external local oscillator (LO) such as the HP 8656B Synthesized Signal Generator. Selecting an external LO with the fine frequency resolution also improves the analyzer's tuning resolution, which can be as coarse as 2 kHz at 1300 MHz. Using an HP 8656B signal generator gives you 10 Hz resolution up to 990 MHz. Dedicating a signal generator as the external LO is not necessary. When not being used as the LO, a built-in RF switch in the HP 8902A routes the signal generator's output to the rear panel of the analyzer.

RF Power: As Accurate as the Best Power Meter

The HP 8902A performs your power measurements with superb accuracy and measurement ease. Power meter linearity is ± 0.02 dB ± 0.02 dB per range change. With a single key stroke the HP 8902A automatically senses the power sensor type, autoranges to the input signal, measures its power, compensates for the sensor flatness, and displays the results in the units you desire. In addition to the HP 11722A Sensor Module, the HP 8902A accepts the HP 11792A Sensor Module and all HP 8480 series power sensors for power measurements from -70 dBm (100 pW) to $+44$ dBm (25W) at frequencies from 100 kHz to 50 GHz.

If you change sensors, just enter the new calibration factors into the instrument's non-volatile memory, either from the keyboard, via HP-IB, or recall them from non-volatile memory. You can store two complete sets of sensor calibration factors.

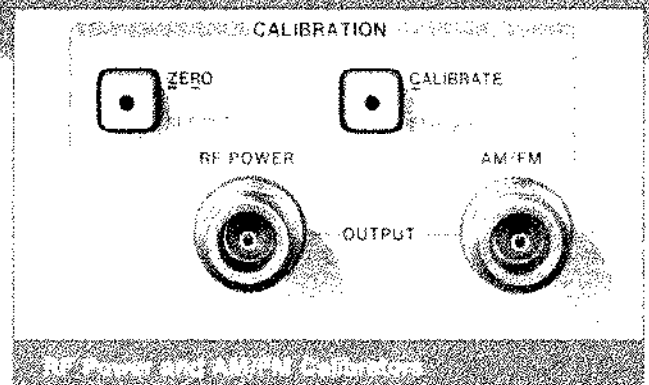

The front-panel Power Reference enables precise calibration of your power sensor at the reference calibration factor frequency. This 50 MHz reference is set to 1.00 mW $\pm 0.7\%$, traceable to the U.S. National Bureau of Standards.

AM, FM and ϕ M: Superb Accuracy

Precise AM, FM, and ϕ M measurements are a major contribution of the HP 8902A Measuring Receiver. Basic measurement accuracy is $\pm 1\%$ for AM and FM and $\pm 3\%$ for ϕ M. With excellent separation between the FM discriminator and AM detector, incidental AM and FM measurements are made easily and accurately.

Residual AM in a 50 Hz to 3 kHz bandwidth is $<0.01\%$. The very low noise FM discriminator makes residual FM measurements of <1 Hz at 100 MHz, increasing linearly with frequency to <8 Hz at 1300 MHz.

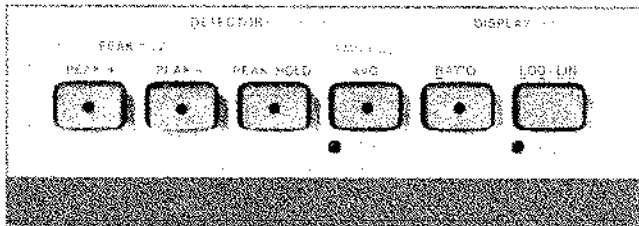

Select from six detectors for modulation measurements. In addition to positive and negative peak detectors, the HP 8902A provides a \pm Peak/2 detec-

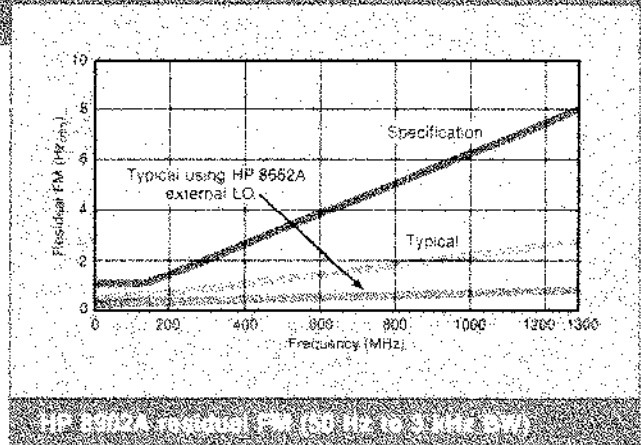

tor. For residual noise measurements, choose from an average responding detector which is rms sine-wave calibrated or a true rms detector. The PEAK HOLD detector captures and holds the maximum positive or negative peak modulation.

The AM/FM calibrator provides extremely accurate modulated signals with $\pm 0.1\%$ accuracy for easy self-check and recalibration of the instrument's AM and FM calibration factors.

RF Frequency: High Resolution

The HP 8902A Measuring Receiver counts all types of modulated signals with 1 Hz resolution. There is a high stability reference option with an aging rate of $<1 \times 10^{-9}$ /day. For selectively counting signals, use the HP 8902A's manual tune mode, or for extended sensitivity use the instrument special functions to count signals to -100 dBm.

Audio: Built-in Convenience

The HP 8902A's audio capabilities often eliminate the need for external equipment when measuring demodulated signals or external audio signals. The HP 8902A counts audio frequencies with 6 digits of resolution, measures distortion of 400 Hz and 1000 Hz signals, and measures rms levels from 100 mV to 3V with $\pm 4\%$ accuracy.

Features You Want

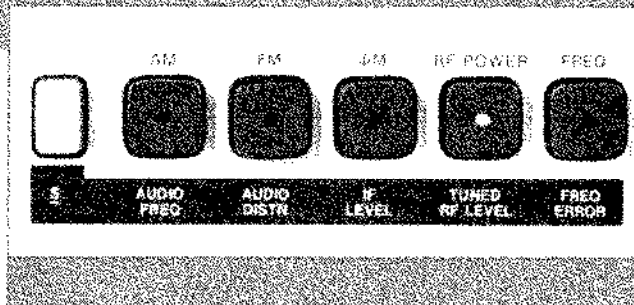

Single-Key Measurements

The HP 8902A is very easy to use. In automatic operation, major functions are selected with a single key. No manual tuning or range selection is needed. The front panel is simple, uncluttered, and easy to use.

Display Flexibility

The HP 8902A offers numerous data display formats. For example, RF power and tuned RF level can be displayed in watts, dBm, volts, dBV, mV, dB mV, μ V, and dB μ V. Use the RATIO and LOG/LIN keys to display results in dB or % relative to either a measured value or a value entered from the keyboard. These features eliminate the need for recalculating measurement results.

Flexible Tuning Modes

In normal operation, the HP 8902A Measuring Receiver is fully automatic. You select the measurement and the HP 8902A tunes to the largest signal present. If selective tuning is needed, enter the approximate frequency on the keyboard. Use Track mode to follow signals which vary in frequency.

Tracks Drifting Signals

Drifting signals may be hard for other instruments to track, but not the HP 8902A. The HP 8902A Measuring Receiver offers two track mode functions optimized for your measurement needs. For modulation and frequency measurements, the wide-IF-bandwidth track mode function tracks and measures drifting signals without sacrificing measurement bandwidth or level sensitivity. For level measurements, the narrow-IF-bandwidth track mode function tracks and selectivity measures low-level drifting signals. Using the average detector, the HP 8902A makes accurate level measurements on drifting signals down to -100 dBm in a 30 kHz bandwidth and down to -90 dBm in a 200 kHz bandwidth.

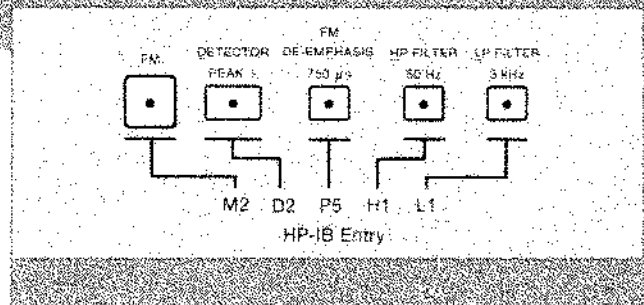

Fully Programmable

All HP 8902A functions are fully programmable via the Hewlett-Packard Interface Bus (HP-IB).

Special Functions

The HP 8902A's keyboard special functions extend your control over the instrument. Some examples of this include measuring SINAD and external audio signals, selecting frequency count resolution, and signaling when a measured value exceeds a previously entered limit.

Special functions also allow you to extend measurement ranges. For example, you can insert RF gain to increase input sensitivity for modulation and RF frequency measurements to approximately -100 dBm. For verifying instrument operation or assisting in servicing, use the special functions to display internal signal voltages and frequencies.

Selectable Filters

Independently-selectable high-pass and low-pass audio filters remove undesired signals such as harmonics, noise and spurious from the recovered modulation signal. The >20 kHz Bessel filter minimizes overshoot with squarewave modulation. There are also four de-emphasis networks for common FM communication and broadcast applications.

Store and Recall

You can store eight complete instrument settings in non-volatile memory and recall them as needed. With this feature for example you can save eight sets of AM, FM and tuned RF level calibration factors.

Expanding Your Capabilities

Operation to Microwave Frequencies

The HP 8902S Microwave Measurement System extends the superb measurement performance of the HP 8902A Measuring Receiver to microwave frequencies. The HP 8902S system delivers the accuracy and resolution of a high performance power meter at frequencies from 50 MHz to 26.5 GHz and levels from +30 dBm to -105 dBm. It accurately measures AM, FM and ϕ M, including residuals and incidentals, with a single keystroke. The HP 8902S counts signals to 20 GHz with 10 Hz resolution, (to 26.5 GHz with 100 Hz resolution) and excellent long-term frequency stability.

The HP 8902S Microwave Measurement System consists of the HP 8902A Measuring Receiver, HP 11793A Microwave Converter, HP 11792A Sensor Module, an instrument controller, HP 11794A Software Pac and a choice of microwave local oscillators. You can choose from the HP 8672A and 8673B/D/E Synthesized Signal Generators and the HP 8340A and HP 8341A Sweep Oscillators.

For more information, refer to the HP 8902S technical data sheet.

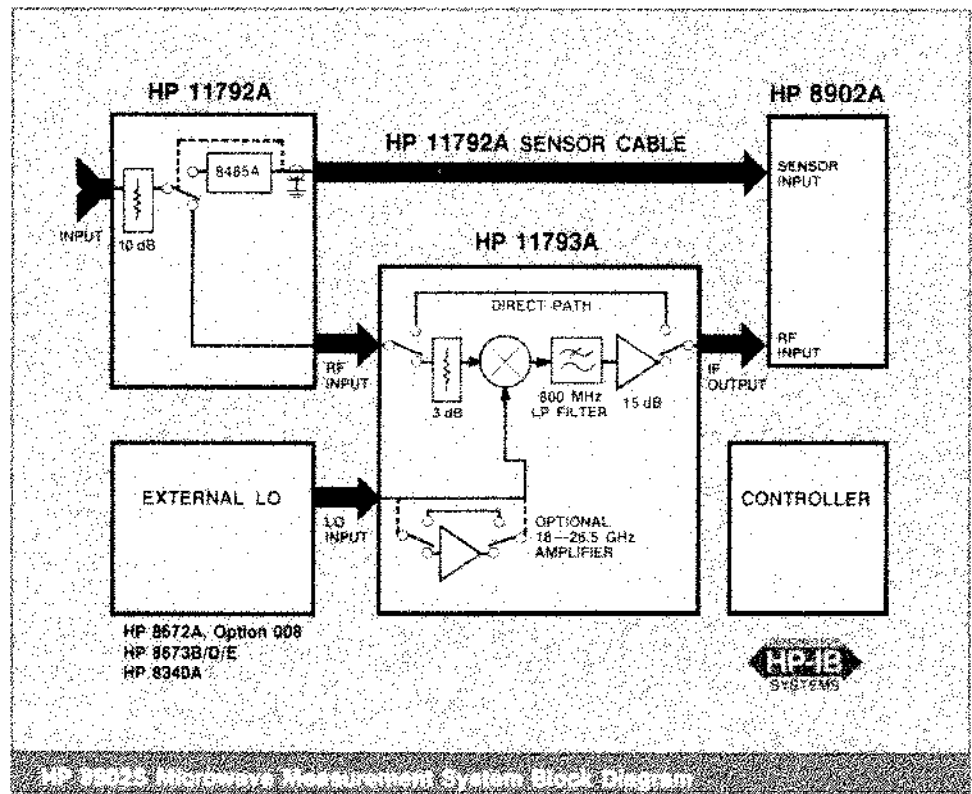
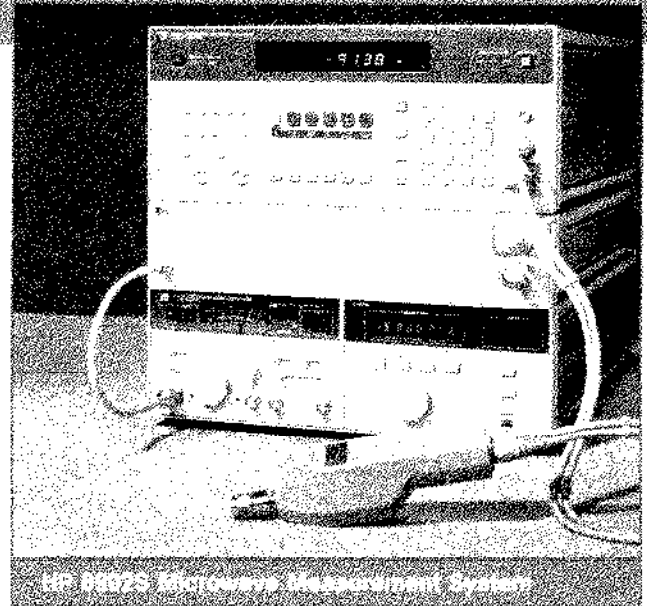

Expanding Your Capabilities

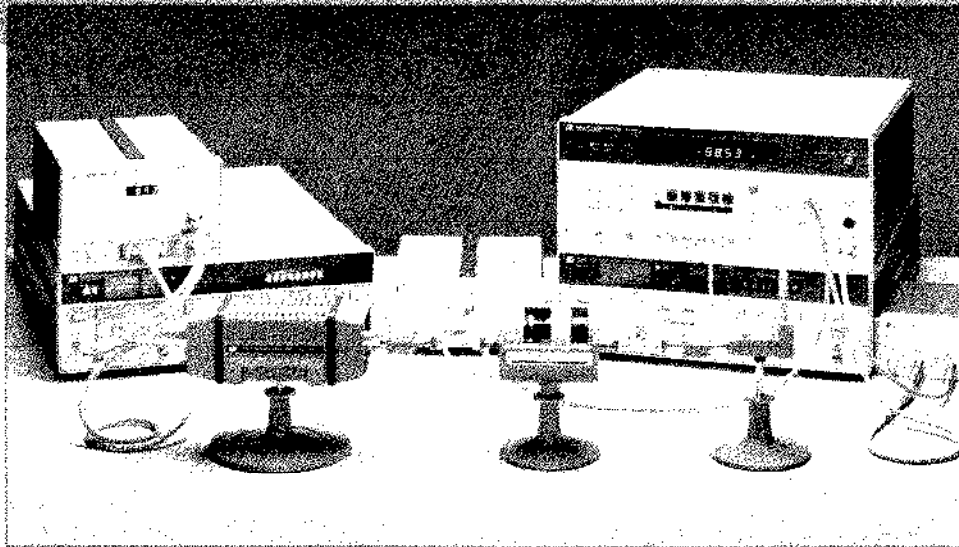

HP 8902A configured for millimeter measurements

Operation to Millimeter Frequencies

Using harmonic mixing, the HP 8902A's frequency, level, and modulation performance can be further extended from 26.5 GHz to 110 GHz, and absolute power measurements can be made to 50 GHz with waveguide power sensors. Simple to configure and operate, this system consists of the HP 8902A Measuring Receiver, HP 11970 Series Harmonic Mixers, HP 11975A Amplifier, HP 8486A Series Waveguide Power Sensors, HP 8447D Amplifier and a synthesized microwave local oscillator. Product Note 8902A-2 describes how HP 8902A millimeter measurements are made, and typical measurement uncertainties.

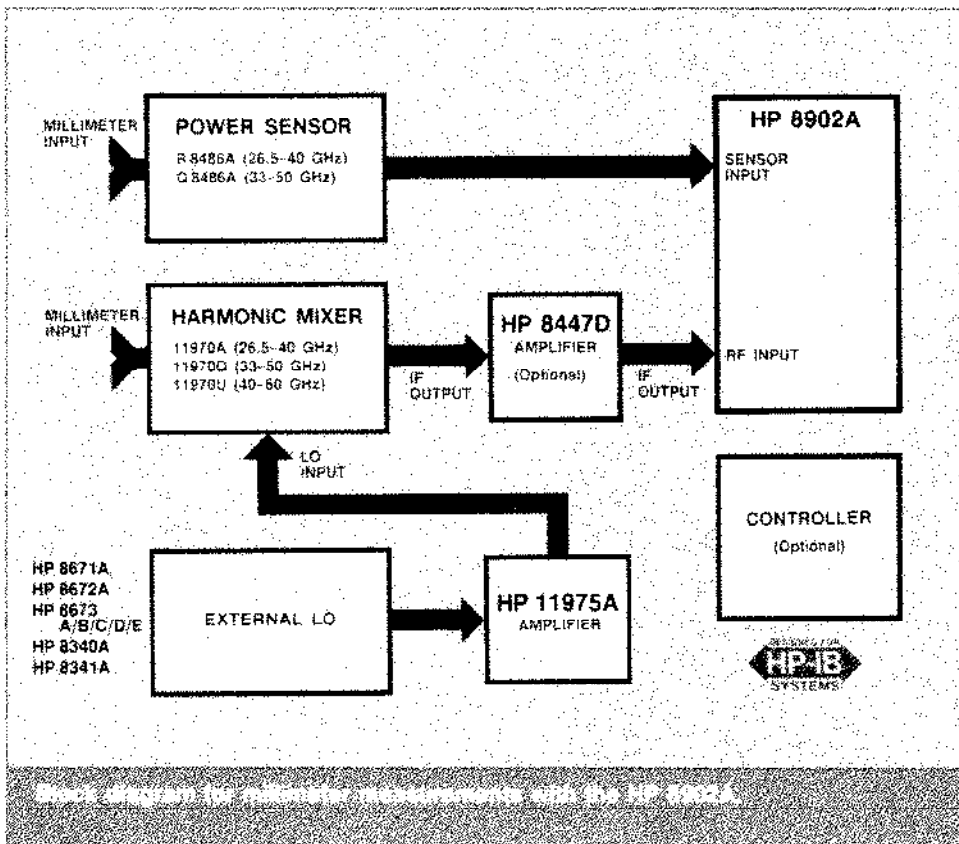

Block diagram for millimeter measurements with the HP 8902A

Signal Generator and Attenuator Calibration

The HP 8952S Signal Generator Test System eases your signal generator calibration workload, performing automatic performance verification for incoming inspection, maintenance, and calibration. The HP 8952S includes the HP 8902A Measuring Receiver, the HP 8903B Audio Analyzer, a printer, and your choice of four HP 9000 controllers: Model 216S, 220S, 226S, and 236S. Extending the HP 8952S to microwave or millimeter frequencies is simple: just add the down-conversion equipment from the HP 8902S microwave or millimeter measurement systems to the HP 8952S Signal Generator Test System. For example, to extend the HP 8952S system to 26 GHz, you would add the 11792A Sensor Module, 11793A Microwave Converter and a 26 GHz synthesized signal source such as the HP 8673B or 8673D Signal Generator or the HP 8340A Sweep Oscillator.

The HP 8952S Test System makes fast, accurate and repeatable measurements and provides you with a hardcopy output of the results. The system is easy to use and is easily expanded to include additional instruments. The system performs 80% of all tests typically required to verify both RF and microwave signal generator performance.

To test your HP signal generators (HP 8640B, 8656A/B, 8642A/B, 8662A, 8663A, 8672A, and 8673A/B/C/D/E), select from the HP 11795A Software Pac series. Each Software Pac follows the verification procedures called out by the signal generator service manual.

To test your attenuators, add the HP 11806A Attenuator Software Pac. The HP 11806A Software Pac characterizes your fixed, variable and programmable attenuator's relative attenuation, absolute attenuation and VSWR performance, and provides a hardcopy output of the results. You can configure your attenuator calibration system as an HP 8902S system or 8952S system (the HP 8903A/B is not required in the HP 8952S system for attenuator testing). Use the application matrix shown at the right to help configure your system. Software pacs are continually being added to test other RF and microwave signal generators and more. For more information, refer to the HP 8952S technical data sheet.

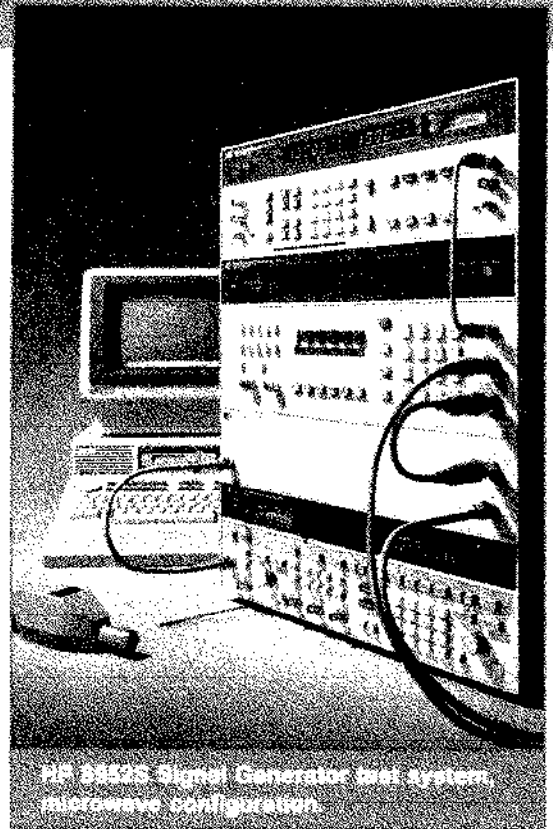

HP 8902A, 8902S, and 8952S Application Matrix

FREQ. RANGE	APPLICATIONS			REQUIRED EQUIPMENT			
	Signal Characterization	Attenuation Calibration	Signal Generator Calibration				
150 kHz to 1.3 GHz	HP 8902A Equip. 1 and A	HP 8952S or 8902S Equip. 1 and B	HP 8952S Equip. 1 and C	1 HP 8902A, 11722A			
150 kHz to 26.5 GHz	HP 8902S Equip. 2 and A	HP 8952S or 8902S Equip. 2 and B	HP 8952S Equip. 2 and C	2 HP 8902A, 11792A, 11793A, External LO			
26.5 GHz to 110 GHz	HP 8902S Equip. 3 and A	HP 8952S or 8902S Equip. 3 and B	HP 8952S Equip. 3 and C	3 HP 8902A, 11970 Mixer, 8486A Power Sensor, 8447D Amplifier, 11975A Amplifier, External LO			
<table border="0" style="width: 100%;"> <tr> <td style="width: 33%; text-align: center;"> A Controller (optional) </td> <td style="width: 33%; text-align: center;"> B Controller, Printer, DUT Source, HP 11806A Software, Directional Bridge, Attenuators/Isolators, Power Splitter/Directional Coupler, Power Sensor </td> <td style="width: 33%; text-align: center;"> C Controller, Printer, HP 11795A Software, 8903B Audio Analyzer OPTIONAL Spectrum Analyzer, Pulse/Function Generator, Oscilloscope Measurement System </td> </tr> </table>					A Controller (optional)	B Controller, Printer, DUT Source, HP 11806A Software, Directional Bridge, Attenuators/Isolators, Power Splitter/Directional Coupler, Power Sensor	C Controller, Printer, HP 11795A Software, 8903B Audio Analyzer OPTIONAL Spectrum Analyzer, Pulse/Function Generator, Oscilloscope Measurement System
A Controller (optional)	B Controller, Printer, DUT Source, HP 11806A Software, Directional Bridge, Attenuators/Isolators, Power Splitter/Directional Coupler, Power Sensor	C Controller, Printer, HP 11795A Software, 8903B Audio Analyzer OPTIONAL Spectrum Analyzer, Pulse/Function Generator, Oscilloscope Measurement System					
REQUIRED EQUIPMENT							

Reliability And Serviceability You Expect

Designed-In Reliability

High reliability is a key feature of the HP 8902A Measuring Receiver. Thorough stress analyses under actual operating conditions were performed on every component. Parts used in the HP 8902A are carefully evaluated on an ongoing basis, and many are burned in, reducing failures. Careful design of internal airflow minimizes internal temperature rise, significantly extending component life.

Your HP 8902A will operate properly even under harsh environmental conditions. Extensive environmental stress testing has been performed on production instruments and the instrument is periodically requalified, ensuring you the highest quality.

Built-In Diagnostics

Many features of the HP 8902A aid in troubleshooting and repair. You can check many internal circuits with the covers on. Front panel special functions perform extensive self-diagnostics and display internal signal voltages and frequencies. Remove the top cover and you gain access to the RF cables, test points, indicators and adjustments. If repair should become necessary, you can remove any circuit or assembly in seconds with only a screwdriver and connector wrench.

HP 11722A Sensor Module

A Single RF Connection for All Measurements

With the HP 11722A Sensor Module, you get all the performance of the Measuring Receiver, plus superb power measurement accuracy, at a single connector. Now, you can characterize a signal without switching back and forth between the power sensor and the analyzer's RF input.

Very Low Input SWR and Insertion Loss

Special care is taken with each sensor module to minimize input SWR and resulting errors. A low-SWR attenuator isolates the power sensor from the source under test, reducing mismatch. Microwave hardware and a selected RF input cable further improve SWR and insertion loss.

Zero the Sensor with One Keystroke

You can zero the HP 11722A's power sensor without removing it from the source under test. Just push the ZERO key. After eight seconds, zeroing completes and the new zero offsets are stored automatically.

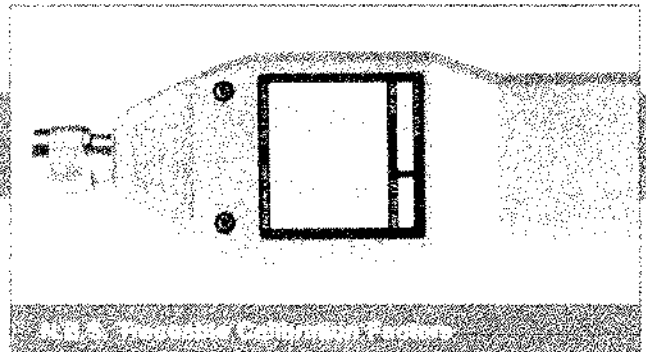

Individually Calibrated

Each HP 11722A Sensor Module is individually calibrated, traceable to the U.S. National Bureau of Standards. The calibration factors are printed on the sensor module for easy reference. Enter these factors into the HP 8902A's non-volatile memory and the instrument automatically compensates for the power sensor's efficiency and mismatch loss at each frequency.

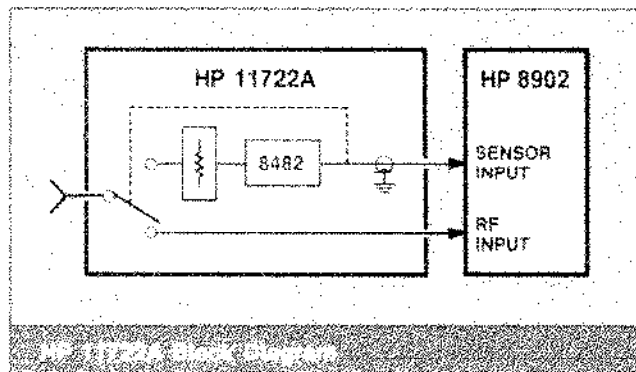

HP 8902A Specifications

Frequency Modulation

RATES⁶:

20 Hz to 10 kHz, $150 \text{ kHz} \leq f_c < 10 \text{ MHz}$.
 20 Hz to 200 kHz, $10 \text{ MHz} \leq f_c \leq 1300 \text{ MHz}$.

DEVIATIONS⁶:

40 kHz_{peak} maximum, $150 \text{ kHz} \leq f_c < 10 \text{ MHz}$.
 400 kHz_{peak} maximum, $10 \text{ MHz} \leq f_c \leq 1300 \text{ MHz}$.

ACCURACY^{1,2,6}:

FM Accuracy	Frequency Range	Rates	Deviations
$\pm 2\%$ of reading ± 1 digit	250 kHz-10 MHz	20 Hz-10 kHz	$\leq 40 \text{ kHz}_{\text{peak}}$
$\pm 1\%$ of reading ± 1 digit	10 MHz-1300 MHz	50 Hz-100 kHz	$\leq 400 \text{ kHz}_{\text{peak}}$
$\pm 5\%$ of reading ± 1 digit	10 MHz-1300 MHz	20 Hz-200 kHz	$\leq 400 \text{ kHz}_{\text{peak}}$

For rms detector add $\pm 3\%$ of reading.

DEMOLATED OUTPUT DISTORTION^{6,7}:

THD	Frequency Range	Rates	Deviations
<0.1%	400 kHz-10 MHz	20 Hz-10 kHz	<10 kHz
<0.1%	10 MHz-1300 MHz	20 Hz-100 kHz	<100 kHz

AM REJECTION (50 Hz to 3 kHz BW)²:

AM Rejection	Frequency Range	Rates	AM Depths
<20 Hz peak deviation	150 kHz-1300 MHz	400 Hz or 1 kHz	$\leq 50\%$

RESIDUAL FM (50 Hz to 3 kHz BW): $< 8 \text{ Hz}_{\text{rms}}$ at 1300 MHz, decreasing linearly with frequency to $< 1 \text{ Hz}_{\text{rms}}$ for 100 MHz and below.

Supplemental Characteristics:

MAXIMUM FM DEVIATION, RESOLUTION, AND MAXIMUM DEMOLATED OUTPUT SENSITIVITY ACROSS AN OPEN CIRCUIT (600 Ω output impedance)⁵:

Maximum Resolution	Maximum Demolated Output Sensitivity	Deviations (ΔF)
100 Hz	0.01 mV/Hz	$\Delta F_{\text{peak}} \geq 40 \text{ kHz}$
10 Hz	0.1 mV/Hz	$4.0 \text{ kHz} \leq \Delta F_{\text{peak}} < 40 \text{ kHz}$
1 Hz	1.0 mV/Hz	$\Delta F_{\text{peak}} < 4 \text{ kHz}$
0.1 Hz (rms detector only)	1.0 mV/Hz	$\Delta F_{\text{rms}} < 0.3 \text{ kHz}$

Resolution is increased one digit with 750 μs de-emphasis and pre-display on.

The demolated output signal present at the Modulation Out/Audio In connector is increased in amplitude by a factor of 10 with 750 μs de-emphasis.

DEMOLATED OUTPUT DISTORTION⁷:

THD	Frequency Range	Rates	Deviations
<0.3%	150 kHz-400 kHz	20 Hz-10 kHz	<10 kHz

SPECIFICATIONS describe the instrument's warranted performance.

SUPPLEMENTAL CHARACTERISTICS (shown in *italics*) are intended to provide information useful in applying the instrument by giving typical, but non-warranted performance parameters.

Supplemental Characteristics, continued:

DETECTORS: +peak, -peak, \pm peak/2, peak hold, average (rms sinewave calibrated), rms.

STEREO SEPARATION (50 Hz to 15 kHz): $> 47 \text{ dB}$.

Amplitude Modulation

RATES:

20 Hz to 10 kHz, $150 \text{ kHz} \leq f_c < 10 \text{ MHz}$.
 20 Hz to 100 kHz, $10 \text{ MHz} \leq f_c \leq 1300 \text{ MHz}$.

DEPTH: to 99%.

ACCURACY^{1,2,3}:

AM Accuracy	Frequency Range	Rates	Depths
$\pm 2\%$ of reading ± 1 digit	150 kHz-10 MHz	50 Hz-10 kHz	5%-99%
$\pm 3\%$ of reading ± 1 digit	150 kHz-10 MHz	20 Hz-10 kHz	to 99%
$\pm 1\%$ of reading ± 1 digit	10 MHz-1300 MHz	50 Hz-50 kHz	5%-99%
$\pm 3\%$ of reading ± 1 digit	10 MHz-1300 MHz	20 Hz-100 kHz	to 99%

For rms detector add $\pm 3\%$ of reading.

FLATNESS^{4,5}:

Flatness	Frequency Range	Rates	Depths
$\pm 0.3\%$ of reading ± 1 digit	10 MHz-1300 MHz	90 Hz-10 kHz	20%-80%

DEMOLATED OUTPUT DISTORTION:

<0.3% THD for $\leq 50\%$ depth.

<0.6% THD for $\leq 95\%$ depth.

FM REJECTION (50 Hz to 3 kHz BW)²:

FM Rejection	Frequency Range	Rates	FM Deviations
<0.2% AM	250 kHz-10 MHz	400 Hz or 1 kHz	<5 kHz _{peak}
<0.2% AM	10 MHz-1300 MHz	400 Hz or 1 kHz	<50 kHz _{peak}

RESIDUAL AM (50 Hz to 3 kHz BW): $< 0.01\%_{\text{rms}}$.

¹ Not to exceed for stated accuracy: 50 Hz to 40 kHz rates with rms detector.

² Peak residuals must be accounted for in peak readings.

³ For peak measurements only: AM accuracy may be affected by distortion generated by the measuring receiver. In the worst case this distortion can decrease accuracy by 0.1% of reading for each 0.1% of distortion.

⁴ Flatness is the variation in indicated AM depth for constant depth on input signal.

⁵ For optimum flatness, cables should be terminated with their characteristic impedance.

⁶ But not to exceed: 20 kHz rates and 40 kHz peak deviations with 750 μs de-emphasis filter.

⁷ With 750 μs de-emphasis and pre-display "off," distortion is not specified for modulation outputs $> 4\text{V}$ peak. This condition can occur near maximum deviation for a measurement range, at rates $< 2 \text{ kHz}$.

HP 8902A Specifications

Amplitude Modulation, continued

Supplemental Characteristics:

DETECTORS: +peak, -peak, \pm peak/2, peak hold, average (rms sinewave calibrated), rms.

MAXIMUM DEPTH, RESOLUTION, AND MAXIMUM DEMODULATED OUTPUT SENSITIVITY ACROSS AN OPEN CIRCUIT (600 Ω output impedance)²:

Maximum Resolution	Maximum Demodulated Output Sensitivity	Depths
0.1%	0.01 V/percent	$AM_{peak} \geq 40.0\%$
0.01%	0.1 V/percent	$AM_{peak} < 40.0\%$
0.001% (rms detector only)	0.1 V/percent	$AM_{rms} < 3.0\%$

Phase Modulation

RATES:

200 Hz to 10 kHz, $150 \text{ kHz} \leq f_c < 10 \text{ MHz}$.
200 Hz to 20 kHz, $10 \text{ MHz} \leq f_c \leq 1300 \text{ MHz}$.

ACCURACY²:

$\pm 4\%$ of reading ± 1 digit, $150 \text{ kHz} \leq f_c < 10 \text{ MHz}$.
 $\pm 3\%$ of reading ± 1 digit, $10 \text{ MHz} \leq f_c \leq 1300 \text{ MHz}$.
For rms detector add $\pm 3\%$ of reading.

DEMODULATED OUTPUT DISTORTION: <0.1% THD.

AM REJECTION (for 50% AM at 1 kHz rate)²:
<0.03 radians peak (50 Hz to 3 kHz BW).

MAXIMUM DEVIATION, RESOLUTION, AND MAXIMUM DEMODULATED OUTPUT SENSITIVITY ACROSS AN OPEN CIRCUIT (600 Ω output impedance)²:

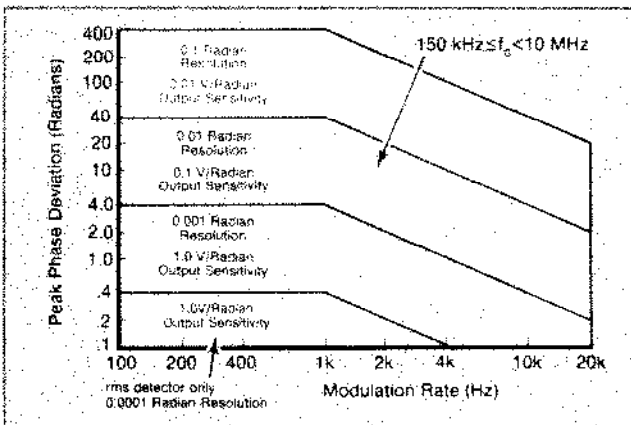

Supplemental Characteristics:

MODULATION RATES: usable from 20 Hz to 100 kHz with degraded performance.

DETECTORS: +peak, -peak, \pm peak/2, peak hold, average (rms sinewave calibrated), rms.

² Peak residuals must be accounted for in peak readings.

³ For optimum flatness, cables should be terminated with their characteristic impedance.

⁴ After 30-day warm-up.

Modulation Reference

AM CALIBRATOR DEPTH AND ACCURACY: 33.33% depth nominal, internally calibrated to an accuracy of $\pm 0.1\%$.

FM CALIBRATOR DEVIATION AND ACCURACY: 34 kHz_{peak} deviation nominal, internally calibrated to an accuracy of $\pm 0.1\%$.

Supplemental Characteristics:

CARRIER FREQUENCY: 10.1 MHz.

MODULATION RATE: 10 kHz.

OUTPUT LEVEL: -25 dBm.

Frequency Counter

RANGE: 150 kHz to 1300 MHz.

SENSITIVITY:

12 mV_{rms} (-25 dBm), $150 \text{ kHz} \leq f_c \leq 650 \text{ MHz}$.
22 mV_{rms} (-20 dBm), $650 \text{ MHz} < f_c \leq 1300 \text{ MHz}$.

MAXIMUM RESOLUTION: 1 Hz.

ACCURACY:

\pm reference accuracy ± 3 counts of least-significant digit, $f_c < 100 \text{ MHz}$.
 \pm reference accuracy ± 3 counts of least-significant digit or 30 Hz, whichever is larger, $f_c \geq 100 \text{ MHz}$.

Supplemental Characteristics:

MODES: Frequency and Frequency Error (displays the difference between the frequency entered via the keyboard and the actual RF input frequency).

SENSITIVITY IN MANUAL TUNING MODE: Approximate frequency must be entered from keyboard. 0.22 mV_{rms} (-60 dBm).

Using the RF amplifier and the IF amplifiers, sensitivity can be increased to approximately -100 dBm.

Internal Time Base Reference

FREQUENCY: 10 MHz.

AGING RATE: $< 1 \times 10^{-6}$ /month.
 $< 1 \times 10^{-9}$ /day (Option 002)⁴.

Supplemental Characteristics:

INTERNAL REFERENCE ACCURACY: Overall accuracy is a function of time base calibration, aging rate, temperature effects, line voltage effects and short-term stability.

	Standard	Option 002
Aging Rate	$< 1 \times 10^{-6}$ /mo.	$< 1 \times 10^{-9}$ /day
Temperature Effects	$< 2 \times 10^{-7}$ /°C	$< 2 \times 10^{-10}$ /°C
Line Voltage Effects (+5%, -10% Line Voltage Change)	$< 1 \times 10^{-6}$	$< 6 \times 10^{-10}$
Short-Term Stability	—	$< 1 \times 10^{-9}$ for 1 sec. average

HP 8902A Specifications

RF Power

The HP 8902A Measuring Receiver, with HP 11722A Sensor Module, performs RF power measurements from -20 dBm ($10 \mu\text{W}$) to $+30$ dBm (1W) at frequencies from 100 kHz to 2.6 GHz. The HP 8902A can be used with the HP 11792A Sensor Module and any of the HP 8480 series Power Sensors (HP 8481A/1B/1H/2A/2B/2H/3A/4A/5A/6A) to make power measurements from -70 dBm (10pW) to $+44$ dBm (25W) at frequencies from 100 kHz to 50 GHz. The HP 8480 Series Sensors also work with the HP 435A, HP 436A and HP 438A Power Meters. Unless otherwise specified, the specifications shown below refer to the HP 8902A only. A detailed explanation of how the uncertainty specifications provided below affect the absolute power measurement accuracy of the HP 8902A is provided in Application Note 64-1.

RF POWER RESOLUTION⁹:

0.01% of full scale in watts or volts mode.

0.01 dB in dBm or $\text{dB}_{\text{relative}}$ mode.

LINEARITY (includes sensor non-linearity): RF range linearity \pm RF range-to-range change error.

RF RANGE LINEARITY (using Recorder Output)¹⁰:

± 0.02 dB, RF ranges 2 through 5.

± 0.03 dB, RF range 1.

Using front-panel display add ± 1 count of least-significant digit.

RF RANGE-TO-RANGE CHANGE ERROR (using Recorder Output): ± 0.02 dB/RF range change from reference range. Using front-panel display add ± 1 count of least-significant digit.

INPUT SWR: < 1.15 , using HP 11722A Sensor Module.

ZERO SET (digital settability of zero): $\pm 0.07\%$ of full scale on lowest range. Decrease by a factor of 10 for each higher range.

Supplemental Characteristics:

ZERO DRIFT OF METER: $\pm 0.03\%$ of full scale/ $^{\circ}\text{C}$ on lowest range. Decrease by a factor of 10 for each higher range.

NOISE (at constant temperature, peak change over any 1-minute interval for the HP 11722A Sensor Module and HP 8481A/1B/1H/2A/2B/2H/3A/5A/6A Sensors):

0.4% of full scale on range 1 (lowest range).

0.13% of full scale on range 2.

0.013% of full scale on range 3.

0.0013% of full scale on range 4.

0.00013% of full scale on range 5.

For HP 8484A Sensor multiply noise by 5 on all ranges.

ZERO DRIFT OF SENSORS (1 hour, at constant temperature after 24-hour warm-up):

$\pm 0.1\%$ of full scale on lowest range for HP 11722A Sensor Module and HP 8481A/1B/1H/2A/2B/2H/3A/5A/6A Sensors.

$\pm 2.0\%$ of full scale on lowest range for HP 8484A Sensor. Decrease by a factor of 10 for each higher range.

RF POWER RANGES OF HP 8902A MEASURING RECEIVER WITH HP 11722A SENSOR MODULE:

-20 dBm to -10 dBm ($10 \mu\text{W}$ to $100 \mu\text{W}$), range 1.

-10 dBm to 0 dBm ($100 \mu\text{W}$ to 1mW), range 2.

0 dBm to $+10$ dBm (1mW to 10mW), range 3.

$+10$ dBm to $+20$ dBm (10mW to 100mW), range 4.

$+20$ dBm to $+30$ dBm (100mW to 1W), range 5.

RESPONSE TIME (0 to 99% of reading):

< 10 seconds, range 1.

< 1 second, range 2.

< 100 milliseconds, ranges 3 through 5.

DISPLAYED UNITS: Watts, dBm, $\text{dB}_{\text{relative}}$, $\%$, $\%$, volts, mV, μV , dB V, dB mV, dB μV .

INTERNAL NON-VOLATILE CAL FACTOR TABLES (user modifiable using special functions):

Maximum Number of Cal Factor/Frequency Entries:

Table #1 (primary): 16 pairs plus Reference Cal Factor.

Table #2 (frequency offset): 22 pairs plus Reference Cal Factor.

Maximum Allowed Frequency Entry: 200 GHz.

Frequency Entry Resolution: 50 kHz.

Cal Factor Range: 40 to 120% .

Cal Factor Resolution: 0.1% .

Power Reference

POWER OUTPUT: 1.00 mW. Factory set to $\pm 0.7\%$, traceable to the U.S. National Bureau of Standards.

ACCURACY: $\pm 1.2\%$ worst case ($\pm 0.9\%$ rss) for one year (0°C to 55°C).

Supplemental Characteristics:

FREQUENCY: 50 MHz nominal.

SWR: 1.05 nominal.

FRONT PANEL CONNECTOR: Type-N female.

Tuned RF Level

POWER RANGE: -127 dBm to 0 dBm, using IF synchronous detector (200 Hz BW).

-100 dBm to 0 dBm, using IF average detector (30 kHz BW).

FREQUENCY RANGE: 2.5 MHz to 1300 MHz.

DISPLAYED RESOLUTION¹¹:

4 digits in watts or volts mode.

0.01 dB or 0.001 dB in dBm or $\text{dB}_{\text{relative}}$ mode.

⁹ The HP 8902A fundamental RF Power measurement units are watts. Further internal processing is done on this number to display all other units.

¹⁰ When using HP 8484A Sensor the noise specification may mask the linearity specification and become the predominant error. When operating on the top RF power range, add the power sensor linearity percentages found in the power sensor specifications.

¹¹ The HP 8902A fundamental Tuned RF Level measurement units are volts. Further internal processing is done on this number to display all other units.

HP 8902A Specifications

Tuned RF Level, continued

RELATIVE MEASUREMENT ACCURACY (at constant temperature and after RF range calibration is completed)¹²: Detector linearity + IF range-to-range error + RF range-to-range error + frequency drift error + noise error ± 1 digit.

DETECTOR LINEARITY:

For IF Synchronous Detector:
 ± 0.007 dB/dB change, but not more than
 ± 0.02 dB/10 dB change.
 Typically $\leq \pm 0.004$ dB/dB change and
 $\leq \pm 0.01$ dB/10 dB change.

For IF Average Detector (0°C to +35°C):
 ± 0.013 dB/dB change, but not more than
 ± 0.04 dB/10 dB change.
 Typically $\leq \pm 0.008$ dB/dB change and
 $\leq \pm 0.02$ dB/10 dB change.

IF RANGE-TO-RANGE ERROR (see Tuned RF Level range plot)¹³:

± 0.02 dB/IF range change, IF ranges 1 through 5.
 ± 0.05 dB/IF range change, IF ranges 6 and 7.

RF RANGE-TO-RANGE ERROR:

± 0.04 dB/RF range change (Tuned RF Level only).
 ± 0.06 dB/RF range change, RF Power to Tuned RF Level.

FREQUENCY DRIFT ERROR: ± 0.05 dB/kHz frequency drift from center of IF (using IF synchronous detector).

NOISE ERROR: ± 0.18 dB for levels < -120 dBm, or for levels < -110 dBm if Special Function 1.9 is selected.

INPUT SWR:

- <1.18, at HP 8902A RF input, RF range 1 and 2.
- <1.40, at HP 8902A RF input, RF range 3.
- <1.33, at HP 11722A RF input, RF range 1 and 2.
- <1.50, at HP 11722A RF input, RF range 3.
- <1.33, at HP 11722A RF input, RF range 3 with Special Function 1.9.

Supplemental Characteristics:

ABSOLUTE LEVEL MEASUREMENT ACCURACY AT LOW LEVELS (at constant temperature and after RF range calibration is completed)¹²:

Absolute level measurement accuracy is a function of the RF Power and Tuned RF Level measurement accuracy. Product Note 8902A-1 explains how both of these measurements affect absolute level measurement accuracy. For a source with an output SWR of 1.7 and level of -110 dBm the typical absolute level measurement accuracy is 0.46 dB rss and 1.02 dB worst case.

IF FREQUENCY: 455 kHz.

ACQUISITION TIME: < 4 seconds, ≥ -110 dBm.
 < 10 seconds, ≥ -127 dBm.

RESPONSE TIME (responding to changes in level of an acquired signal): < 2 seconds, ≥ -110 dBm.
 < 5 seconds, ≥ -127 dBm.

DISPLAYED UNITS: Watts, dBm, dB_{relative}, %_{relative}, volts, mV, μ V, dB V, dB mV, dB μ V.

Supplemental Characteristics, continued:

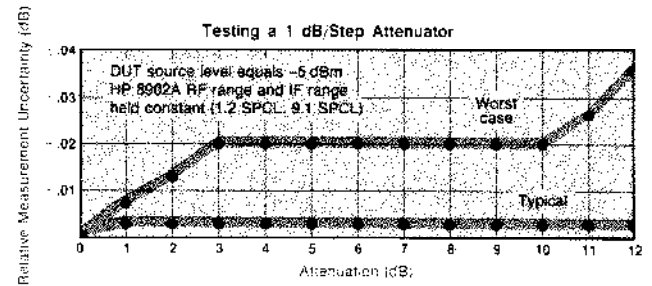
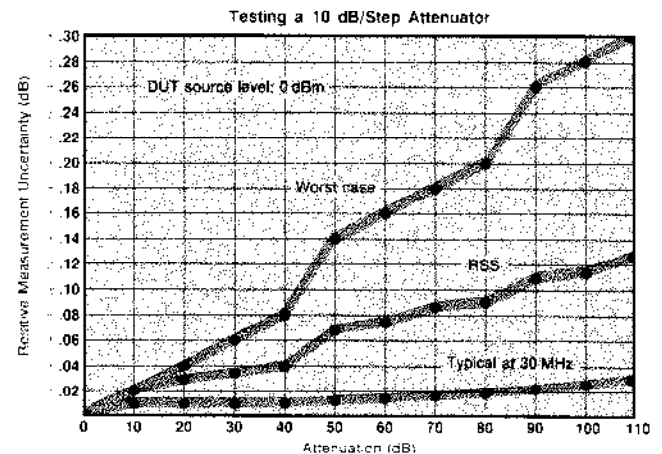
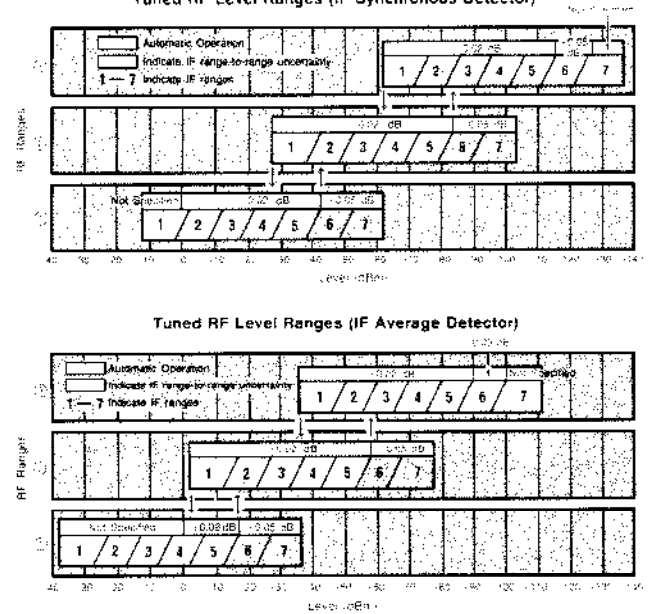

¹¹ The HP 8902A fundamental Tuned RF Level measurement units are volts. Further internal processing is done on this number to display all other units.

¹² Tuned RF Level accuracy will be affected by residual FM of the source-under-test. If the residual FM_{peak} is > 50 Hz measured over a 30 second period in a 3 kHz BW, Tuned RF Level measurements should be made using the IF average detector (30 kHz BW) by using Special Function 4.4. The Tuned RF Level measurement sensitivity when using the IF average detector is -100 dBm.

¹³ IF Ranges 6 and 7 (see Tuned RF Level range plots) are only used in automatic operation for Tuned RF Level measurements below approximately -110 dBm for the IF synchronous detector, and below approximately -85 dBm for the IF average detector.

HP 8902A Specifications

Carrier Noise (Options 030-037)

FREQUENCY RANGE: 10 MHz to 1300 MHz.

CARRIER POWER RANGE: +30 dBm to -20 dBm;

12.5 kHz, 25 kHz and 30 kHz filters.

+30 dBm to -10 dBm; carrier noise filter.

DYNAMIC RANGE: 115 dB.

CARRIER REJECTION (temp. $\leq 35^\circ\text{C}$): >90 dB; for offsets of at least 1 channel spacing or 5 kHz, whichever is greater.

RELATIVE MEASUREMENT ACCURACY: ± 0.5 dB; levels ≥ -95 dBc; 12.5 kHz, 25 kHz and 30 kHz filters. ± 0.5 dB; levels ≥ -129 dBc/Hz; carrier noise filter.

CARRIER NOISE FILTER:

Filter Noise Bandwidth: 2.5 kHz nominal.

Noise Bandwidth Correction Accuracy (stored in non-volatile memory): ± 0.2 dB.

Supplemental Characteristics:

ADJACENT/ALTERNATE CHANNEL FILTERS:

6 dB Filter Bandwidth:

8.5 kHz, 12.5 kHz adjacent-channel filter.

16.0 kHz, 25 kHz adjacent-channel filter.

30.0 kHz, 30 kHz (cellular radio) alternate-channel filter.

TYPICAL NOISE FLOOR: -150 dBc/Hz, 0 dBm carrier power level. For System noise performance add LO contribution.

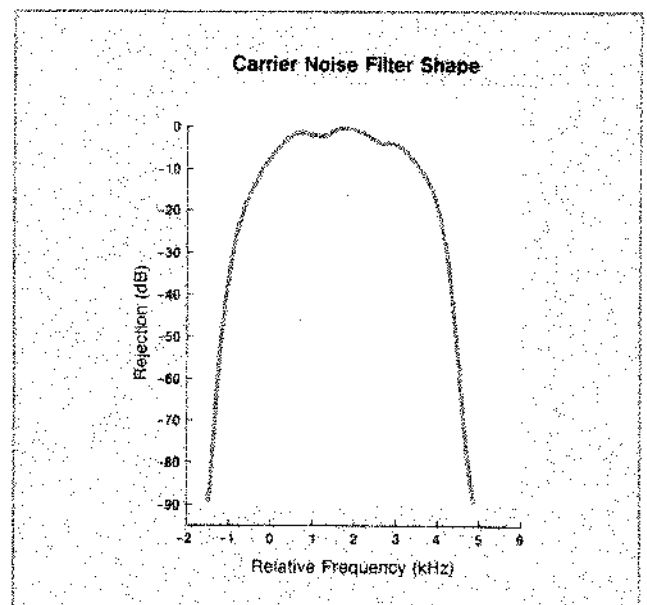
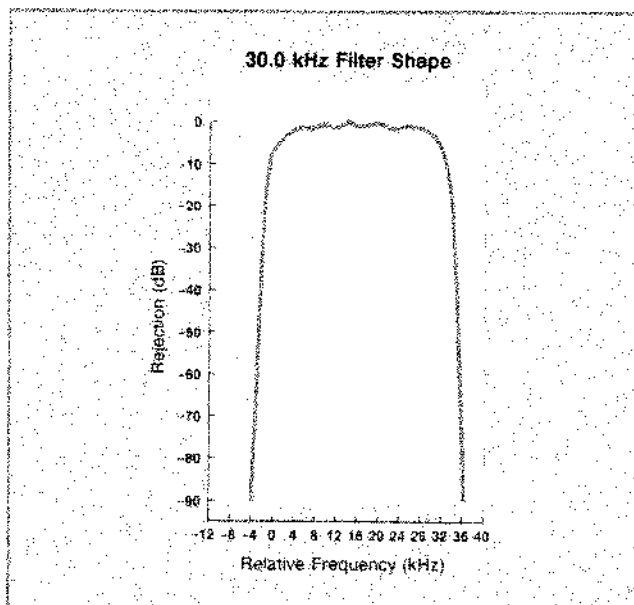
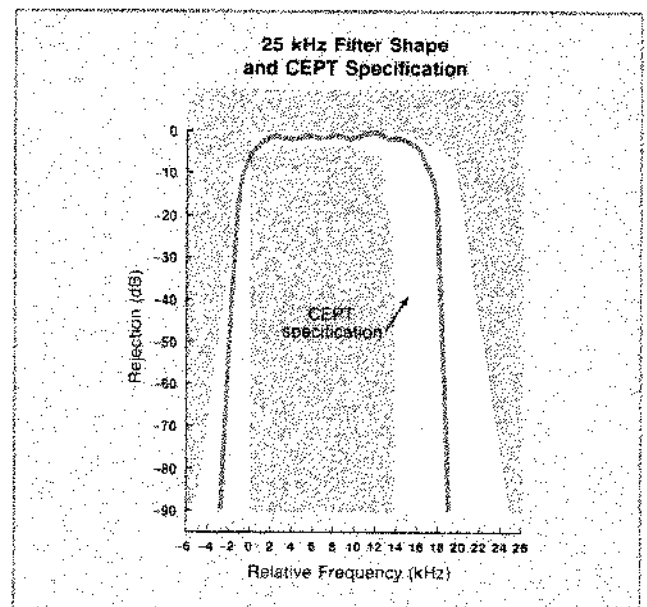
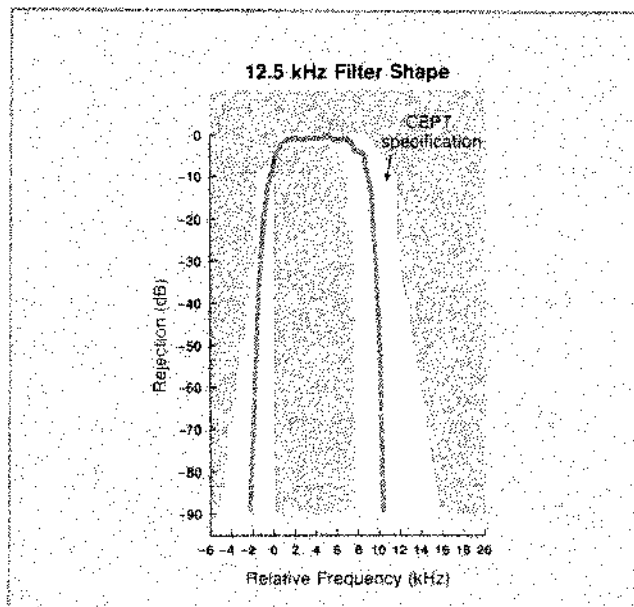

HP 8902A Specifications

Audio Frequency Counter

FREQUENCY RANGE: 20 Hz to 250 kHz (usable to 600 kHz).

MAXIMUM EXTERNAL INPUT VOLTAGE: 3V_{rms}*

ACCURACY (for demodulated signals)¹⁴:

Accuracy	Frequency	Modulation (Peak)
± 3 counts of least-significant digit ± Internal Reference Accuracy	>1 kHz	AM ≥ 10% FM ≥ 1.0 kHz φM ≥ 1.5 radians
± 0.02 Hz ± Internal Reference Accuracy	≤ 1 kHz	AM ≥ 10% FM ≥ 1.0 kHz φM ≥ 1.5 radians
± 0.2 Hz ± Internal Reference Accuracy (3 kHz low-pass filter inserted)	≤ 3 kHz	1.5% ≤ AM < 10% 0.15 kHz ≤ FM < 1.0 kHz 0.15 radian ≤ φM < 1.5 radians

ACCURACY (for external signals)¹⁴:

Accuracy	Frequency	Level
± 3 counts of least-significant digit ± Internal Reference Accuracy	>1 kHz	≥ 100 mV _{rms}
± 0.02 Hz ± Internal Reference Accuracy	<1 kHz	≥ 100 mV _{rms}

Supplemental Characteristics:

DISPLAYED RESOLUTION: 6 digits.

MEASUREMENT RATE: 2 readings per second.

COUNTING TECHNIQUE: Reciprocal with internal 10 MHz time base.

AUDIO INPUT IMPEDANCE: 100 kΩ nominal.

Audio RMS Level

FREQUENCY RANGE: 50 Hz to 40 kHz.

VOLTAGE RANGE: 100 mV to 3V.

ACCURACY: ± 4.0% of reading.

Supplemental Characteristics:

FULL RANGE DISPLAY: .3000V, 4.000V.

AC CONVERTER: True-rms responding for signals with crest factor of ≤ 3.

MEASUREMENT RATE: 2 readings per second.

AUDIO INPUT IMPEDANCE: 100 kΩ nominal.

Audio Distortion

FUNDAMENTAL FREQUENCIES: 400 Hz ± 5% and 1 kHz ± 5%.

MAXIMUM EXTERNAL INPUT VOLTAGE: 3V.

DISPLAY RANGE: 0.01% to 100.0% (-80.00 dB to 0.00 dB).

DISPLAYED RESOLUTION: 0.01% or 0.01 dB.

ACCURACY: ± 1 dB of reading.

SENSITIVITY:

Modulation: 0.15 kHz peak FM, 1.5% peak AM or 0.6 radian peak φM.

External: 100 mV_{rms}*

RESIDUAL NOISE AND DISTORTION¹⁵:

0.3% (-50 dB), temperature < 40°C.

Supplemental Characteristics:

MEASUREMENT 3 dB BANDWIDTH: 20 Hz to 50 kHz.

DETECTION: True rms.

MEASUREMENT RATE: 1 reading per second.

AUDIO INPUT IMPEDANCE: 100 kΩ nominal.

Audio Filters

DE-EMPHASIS FILTERS: 25 μs, 50 μs, 75 μs, and 750 μs.

De-emphasis filters are single-pole, low-pass filters with 3 dB frequencies of: 6366 Hz for 25 μs, 3183 Hz for 50 μs, 2122 Hz for 75 μs, and 212 Hz for 750 μs.

50 Hz HIGH-PASS FILTER (2 pole):

Flatness: < 1% at rates ≥ 200 Hz.

300 Hz HIGH-PASS FILTER (2 pole):

Flatness: < 1% at rates ≥ 1 kHz.

3 kHz LOW-PASS FILTER (5 pole):

Flatness: < 1% at rates ≤ 1 kHz.

15 kHz LOW-PASS FILTER (5 pole):

Flatness: < 1% at rates ≤ 10 kHz.

> 20 kHz LOW-PASS FILTER (9 pole Bessel)¹⁶:

Flatness: < 1% at rates ≤ 10 kHz.

Supplemental Characteristics:

DE-EMPHASIS FILTER TIME CONSTANT

ACCURACY: ± 3%.

HIGH-PASS AND LOW-PASS FILTER 3 dB CUTOFF

FREQUENCY ACCURACY: ± 3%.

> 20 kHz LOW PASS FILTER 3 dB CUTOFF

FREQUENCY: 100 kHz nominal.

OVERSHOOT ON SQUARE WAVE MODULATION¹⁶:

< 1%.

¹⁴ With the low-pass and high-pass audio filters used to stabilize frequency readings.

¹⁵ For demodulated signals, the residual noise generated by the HP 8902A must be accounted for in distortion measurements (i.e., residual AM, FM or φM.)

¹⁶ The > 20 kHz low-pass filter is intended for minimum overshoot with square wave modulation.

HP 8902A Specifications

RF Input

FREQUENCY RANGE: 150 kHz to 1300 MHz.

OPERATING LEVEL:

Minimum Operating Level	Maximum Operating Level	Frequency Range
12 mV _{rms} (-25 dBm)	7 V _{rms} (1W _{peak}) Source SWR <4	150 kHz-650 MHz
22 mV _{rms} (-20 dBm)	7 V _{rms} (1W _{peak}) Source SWR <4	650 MHz-1300 MHz

Supplemental Characteristics:

TUNING:

Normal Mode: Automatic and manual frequency entry.

Track Mode: Automatic and manual frequency entry, $f_c \geq 10$ MHz.

Acquisition Time (automatic operation):
~1.5 seconds.

INPUT IMPEDANCE: 50Ω nominal.

MAXIMUM SAFE DC INPUT LEVEL: 5V.

General Specifications

TEMPERATURE: Operating: 0°C to 55°C.
Storage: -55°C to 75°C.

REMOTE OPERATION: HP-IB; all functions except the line switch are remotely controllable.

HP-IB COMPATIBILITY (defined in IEEE 488-1978):
SH1, AH1, T5, TE0, L3, LE0, SR1, RL1, PP0, DC1, DT1, C0, E1.

EMI: Conducted and radiated interference is within the requirements of VDE 0871 (Level B), and CISPR publication 11.

POWER: 100, 120, 220, or 240V (+5%, -10%); 48-66 Hz; 200 VA maximum.

WEIGHT: Net 23.6 kg. (52 lb.); Shipping 31.4 kg (69 lb).

DIMENSIONS: 190 mm. H × 426 mm. W × 551 mm. D (7.5" × 16.8" × 21.7").

HP SYSTEM II MODULE SIZE: 177.0 H × 1 MW × 497.8 D.

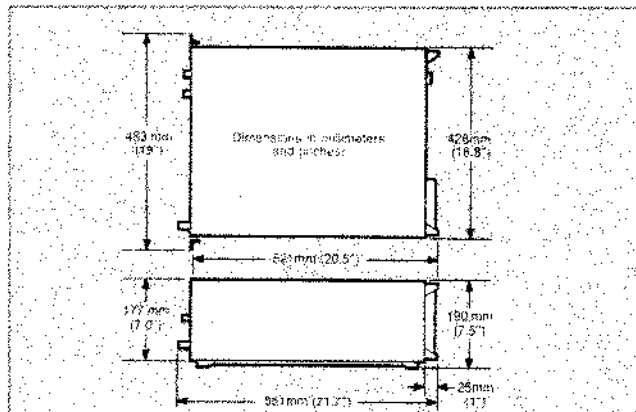

HP 11722A Specifications

HP 11722A Sensor Module

FREQUENCY RANGE: 100 kHz to 2.6 GHz.

POWER RANGE: +30 dBm (1 watt) to -20 dBm (10 μW).

INPUT SWR (connected to an HP 8902A):

<1.15, for RF Power measurements.

<1.33, for Tuned RF Level measurements, RF range 1 and 2.

<1.5, for Tuned RF Level measurements, RF range 3.

<1.33, for Tuned RF Level measurements, RF range 3 with Special Function 1.9.

POWER SENSOR LINEARITY:

+2%, -4%; +30 dBm to +20 dBm.

Negligible deviation, levels <+20 dBm.

CALIBRATION FACTORS: Each HP 11722A Sensor Module is individually calibrated. The calibration factors are printed on the HP 11722A Sensor Module for easy reference.

CAL FACTOR UNCERTAINTY:

Frequency (MHz)	RSS Uncertainty	Worst Case Uncertainty
0.1	0.7%	1.6%
0.3	0.7%	1.6%
1.0	0.8%	1.7%
3.0	0.8%	1.7%
10.0	0.9%	2.0%
30.0	0.9%	2.0%
50.0	0.0% (ref.)	0.0% (ref.)
100.0	1.1%	2.2%
300.0	1.1%	2.2%
1000.0	1.1%	2.2%
2600.0	1.2%	2.3%

Supplemental Characteristics:

MAXIMUM PEAK POWER: 100W_{peak} or 300W · μs per pulse.

INPUT IMPEDANCE: 50Ω nominal.

INPUT CONNECTOR: Type-N male.

SWITCH LIFE: >1,000,000 switchings.

SWITCH ISOLATION: >90 dB.

WEIGHT: Net 0.8 kg. (1.75 lb.); Shipping 1.2 kg. (2.6 lb.).

DIMENSIONS: 51.2 mm. H × 62.4 mm. W × 1935 mm. D (2" × 2.5" × 76.2").

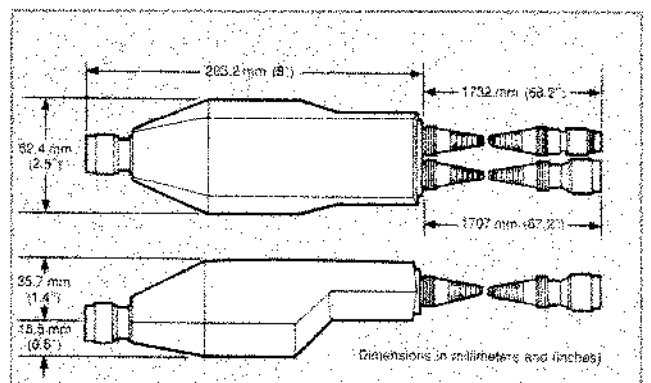

HP 8902A Specifications

Ordering Information

HP 8902A Rear Panel Inputs/Outputs

Supplemental Characteristics:

FM OUTPUT: 10 k Ω impedance, -9V to 6V into an open circuit; ~6V/MHz, dc coupled, 16 kHz bandwidth (one pole).

AM OUTPUT: 10 k Ω impedance, -4V to 0V into an open circuit, ~8 mV/%, dc coupled, 16 kHz bandwidth (one pole).

RECORDER OUTPUT: DC voltage proportional to the measured results, 1 k Ω impedance, 0V to 4V for each resolution range into an open circuit.

IF OUTPUT: 50 Ω impedance, 150 kHz to 2.5 MHz, -27 dBm to -3 dBm.

10 MHz REFERENCE OUTPUT: 50 Ω impedance, TTL levels (0V to >2.2V into an open circuit). Available only with Option 002 1 \times 10⁻⁹/day internal reference.

10 MHz REFERENCE INPUT¹⁷: >500 Ω impedance, 0.5V_{peak-to-peak} minimum input level.

LO INPUT (Option 003): 50 Ω impedance, ~1.27 MHz to 1301.5 MHz, 0 dBm nominal.

RF SWITCH REMOTE CONTROL OUTPUT: Provides output signals necessary to remotely control either an HP 33311B/C Option 011 or an HP 8761A RF switch.

FREQUENCY OFFSET MODE REMOTE CONTROL OUTPUT: TTL high output if in frequency offset mode (Special Function 27.1 or 27.3) with an external LO frequency >0, TTL low output for all other cases.

Model Number and Name

HP 8902A Measuring Receiver

Option 001: Rear panel instead of front panel connections for input, modulation output, and calibrators

Option 002: 1 \times 10⁻⁹/day internal reference oscillator

Option 003: Rear panel connections which allow use with an external local oscillator

Option 004: Operation from 48 Hz to 440 Hz power line (temp. <40°C)

Option 021: Add HP 11722A Sensor Module

Option 030: High selectivity
Option 030 includes rear-panel external local oscillator connections. HP 8902A Option 003, rear-panel external local oscillator connections, may not be ordered with HP 8902A Option 030. Two filter options (032 through 037) must be selected with Option 030.

Option 032: 12.5 kHz adjacent channel filter

Option 033: 25 kHz adjacent channel filter

Option 035: 30 kHz (cellular radio) alternate channel filter

Option 037: Carrier noise filter

Option 907: Front panel handle kit

Option 908: Rack mounting flange kit

Option 909: Front panel handle plus rack mounting flange kit

Option 910: Extra manuals

HP 11722A Sensor Module

Option 910: Extra manual

¹⁷ External reference accuracy affects accuracy of all measurements.